



SECRET JARDIN

ASSEMBLY INSTRUCTIONS



DARK ROOM R4.00

VIDEOS TENTS

**VIDEO ASSEMBLY
DR240W**



**VIDEO ASSEMBLY
DR300**



SPACE BOOSTER, WEBIT, DUCTING & CABLE FLANGES

**VIDEO ASSEMBLY
DUCTING FLANGE**



**VIDEO ASSEMBLY
CABLE FLANGE**



**VIDEO ASSEMBLY
SPACE BOOSTER**





DUCTING FLANGE Ø25



Ducting Flange



Cutting Tool



Connectors

150 - 160 - 200 - 250 mm
6" - 6½" - 8" - 10"



Light Baffle

GENERAL



Space Booster

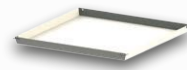

Removable Liner



WebIT



CableIT



StrapIT

CABLE FLANGE Ø7



Cable Flange



Cutting Tool

OPEN ALL ZIP BEFORE ASSEMBLY



OPEN ALL ACCESSES **THEN**
PUT THE CANVAS ON



OUVRIRE TOUT LES ACCÈS **PUIS**
METTRE LA TOILE



ABRIR TODOS LOS ACCESOS
LUEGO PONTE EL LIENZO



ALLE ZUGÄNGE ÖFFNEN **DANN**
LEGEN SIE DIE LEINWANDE AB



ALLE TOEGANGEN OPENSTELLEN
DAN ZET JE HET DOEK OP



APRIRE TUTTI GLI ACCESSI **POI**
METTERE LA TELA DI CANAPA SU

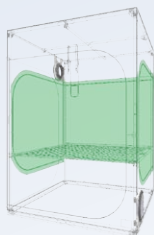
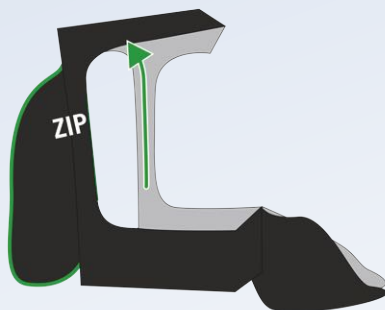
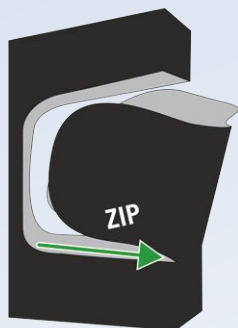

OPEN WINDOWS

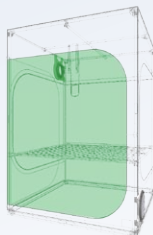

OPEN DOORS



KEEP 3 CARRIAGES TOGETHER AT ONE END



MAINTENIR 3 ZIPS ENSEMBLE À UNE EXTRÉMITÉ



MANTENER 3 CREMALLERAS JUNTAS EN UN EXTREMO



3 REIßVERSCHLÜSSE AN EINEM ENDE ZUSAMMENHALTEN



HOUD 3 RITSEN BIJ ELKAAR AAN ÉÉN KANT



TENERE INSIEME 3 CERNIERE AD UN'ESTREMITÀ

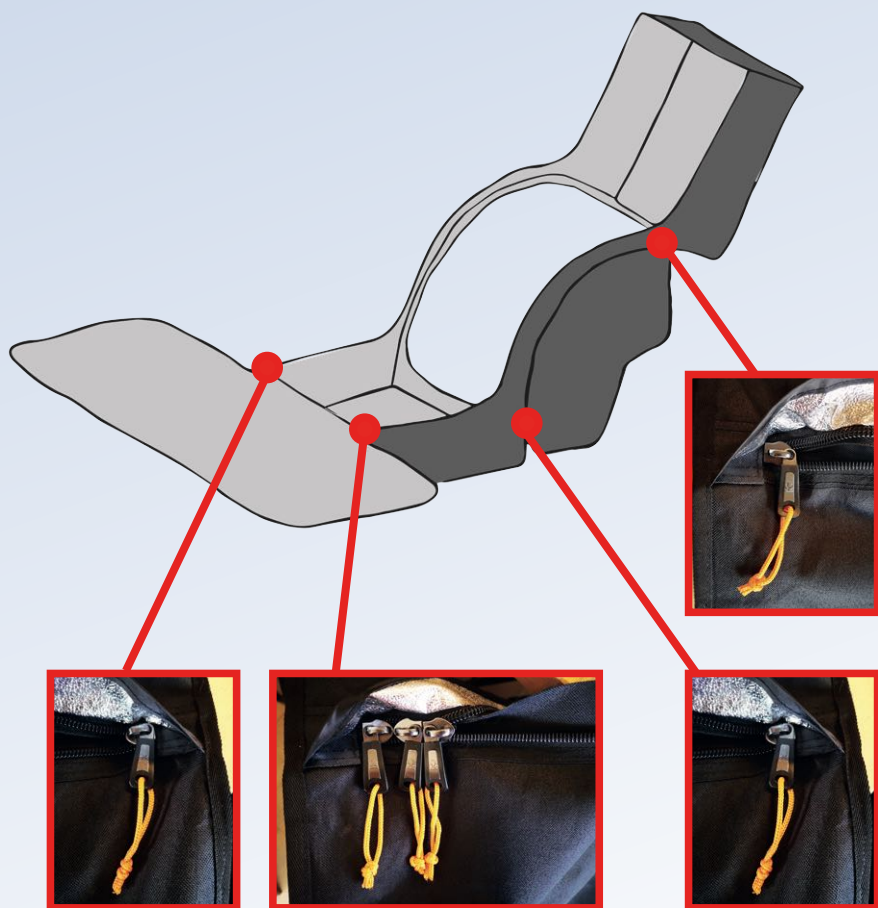

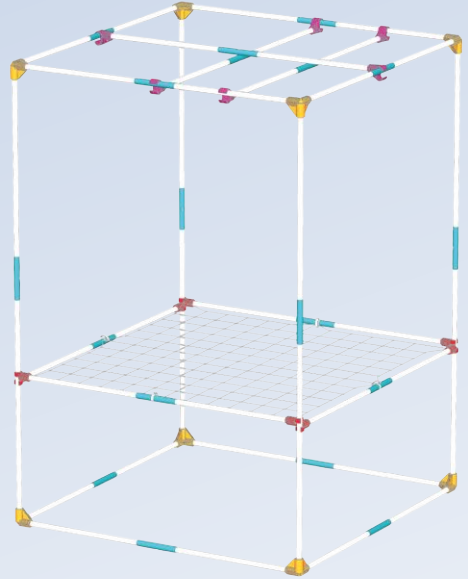
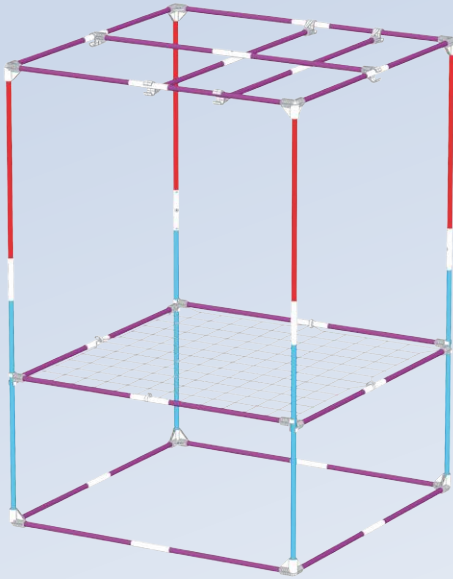

- 4x T25-120
- 4x T25-100
- 30x T25-75
- 19x T25-Link



8x C25-Y



8x C25-SB



6x C25-H

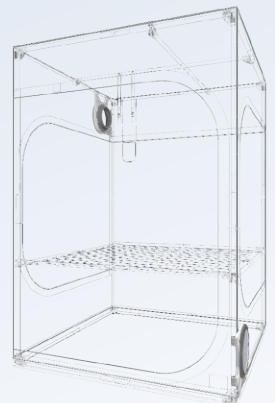

**VIDEO ASSEMBLY
DUCTING FLANGE**



**VIDEO ASSEMBLY
CABLE FLANGE**





PROFESSIONAL

DARK ROOM 150 : CANVAS ASSEMBLY

DR150

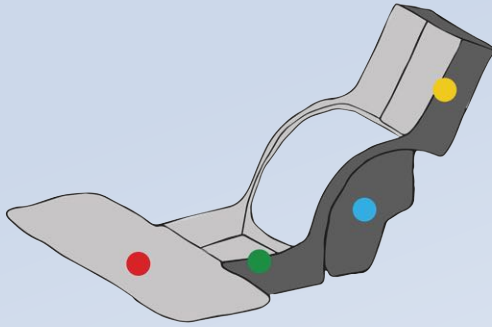

-  TOP
-  DOOR
-  BOTTOM
-  WINDOW

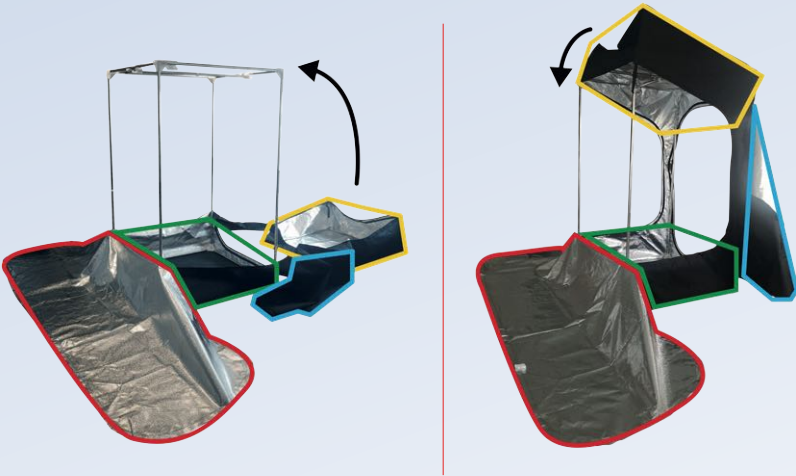

OPEN ALL ZIP BEFORE ASSEMBLY



OPEN ALL ACCESSES **THEN**
PUT THE CANVAS ON



OUVRIRE TOUT LES ACCÈS **PUIS**
METTRE LA TOILE



ABRIR TODOS LOS ACCESOS
LUEGO PONTE EL LIENZO



ALLE ZUGÄNGE ÖFFNEN **DANN**
LEGEN SIE DIE LEINWANDE AB



ALLE TOEGANGEN OPENSTELLEN
DAN ZET JE HET DOEK OP



APRIRE TUTTI GLI ACCESSI **POI**
METTERE LA TELA DI CANAPA SU

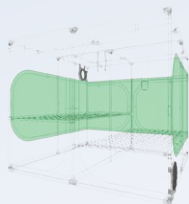
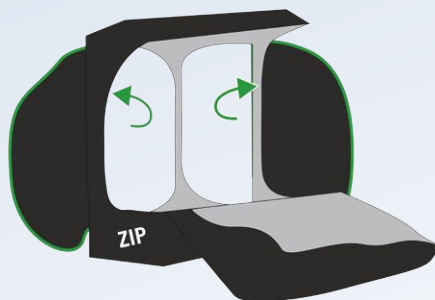
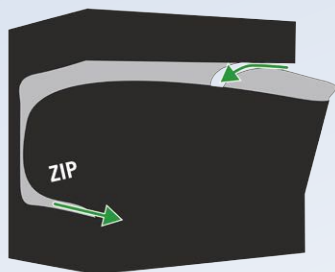

OPEN WINDOWS

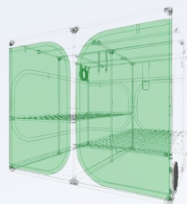

OPEN DOORS



PROFESSIONAL

DARK ROOM 240 : ZIP OPENING

DR240



KEEP 3 CARRIAGES TOGETHER AT ONE END



MAINTENIR 3 ZIPS ENSEMBLE À UNE EXTRÉMITÉ



MANTENER 3 CREMALLERAS JUNTAS EN UN EXTREMO



3 REIßVERSCHLÜSSE AN EINEM ENDE ZUSAMMENHALTEN



HOUD 3 RITSEN BIJ ELKAAR AAN ÉÉN KANT



TENERE INSIEME 3 CERNIERE AD UN'ESTREMITÀ

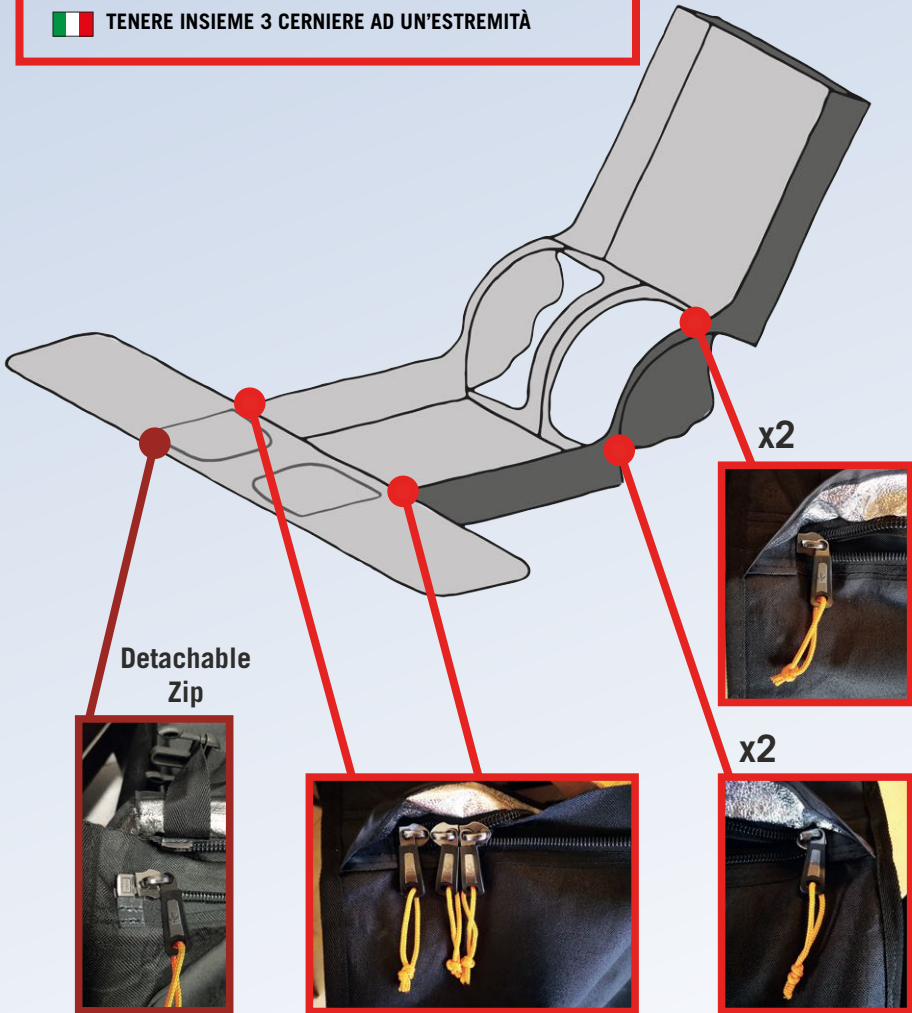



PROFESSIONAL

DARK ROOM 240 : STRUCTURE ASSEMBLY

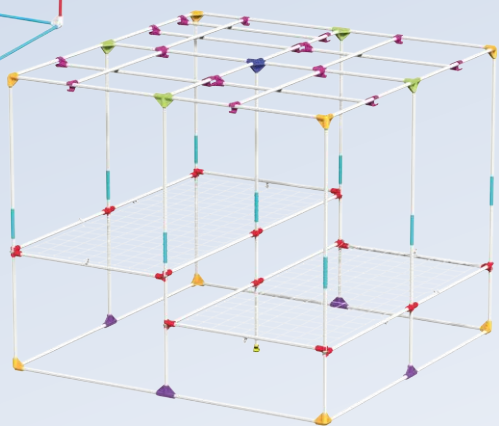
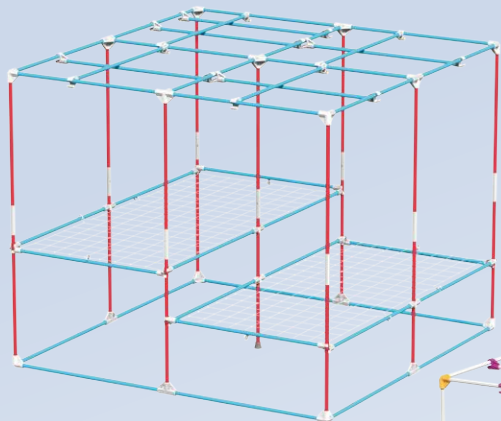

**VIDEO ASSEMBLY
TENT DR300**



8x C25-Y



4x C25-K



4x C25-T



1x C25-XI



1x C25-RF



24x C25-SB



18x C25-H

41x T25-120

18x T25-100

9x T25-Link

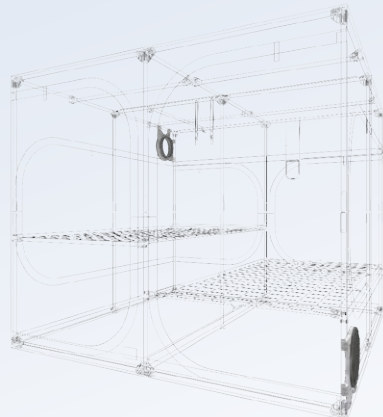
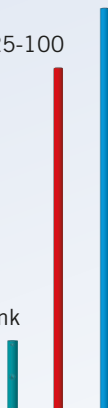

**VIDEO ASSEMBLY
DUCTING FLANGE**



**VIDEO ASSEMBLY
CABLE FLANGE**



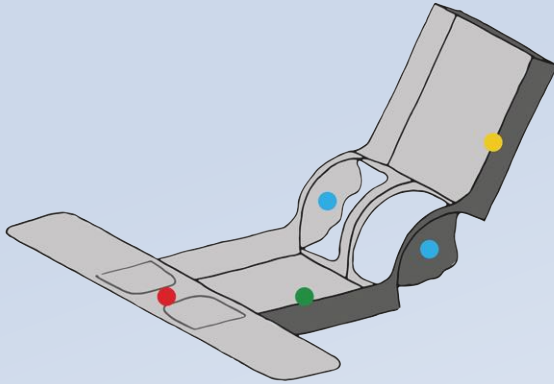

- TOP
- DOOR
- BOTTOM
- WINDOW

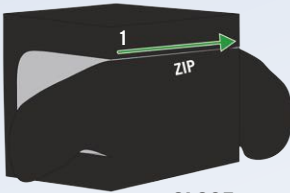
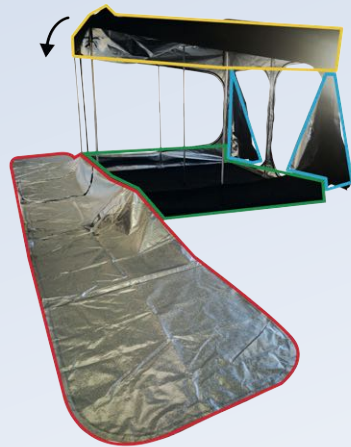
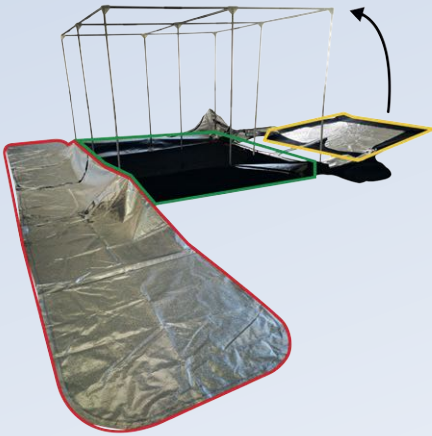

CLOSE
DETACHABLE ZIP

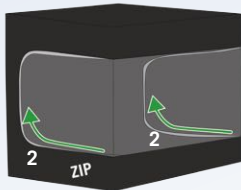

CLOSE ZIP

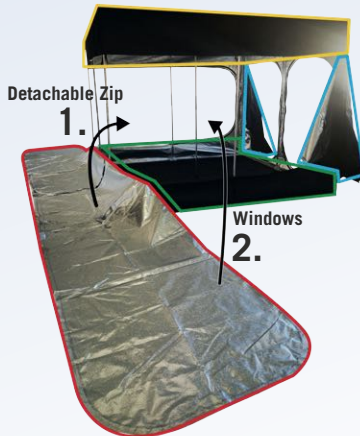

VIDEO



OPEN ALL ZIP BEFORE ASSEMBLY



OPEN ALL ACCESSES **THEN**
PUT THE CANVAS ON



OUVRIER TOUT LES ACCÈS **PUIS**
METTRE LA TOILE



ABRIR TODOS LOS ACCESOS
LUEGO PONTE EL LIENZO



ALLE ZUGÄNGE ÖFFNEN **DANN**
LEGEN SIE DIE LEINWANDE AB



ALLE TOEGANGEN OPENSTELLEN
DAN ZET JE HET DOEK OP



APRIRE TUTTI GLI ACCESSI **POI**
METTERE LA TELA DI CANAPA SU

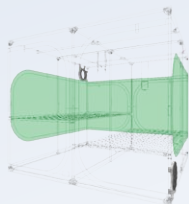
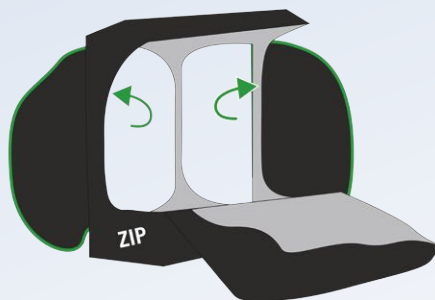
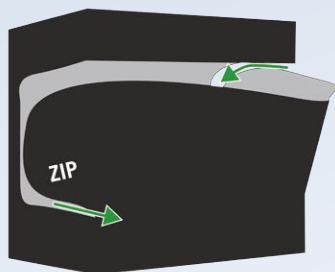

OPEN WINDOWS

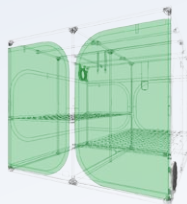

OPEN DOORS



PROFESSIONAL

DARK ROOM 300 : ZIP OPENING



KEEP 3 CARRIAGES TOGETHER AT ONE END



MAINTENIR 3 ZIPS ENSEMBLE À UNE EXTRÉMITÉ



MANTENER 3 CREMALLERAS JUNTAS EN UN EXTREMO



3 REIßVERSCHLÜSSE AN EINEM ENDE ZUSAMMENHALTEN



HOUD 3 RITSEN BIJ ELKAAR AAN ÉÉN KANT



TENERE INSIEME 3 CERNIERE AD UN'ESTREMITÀ

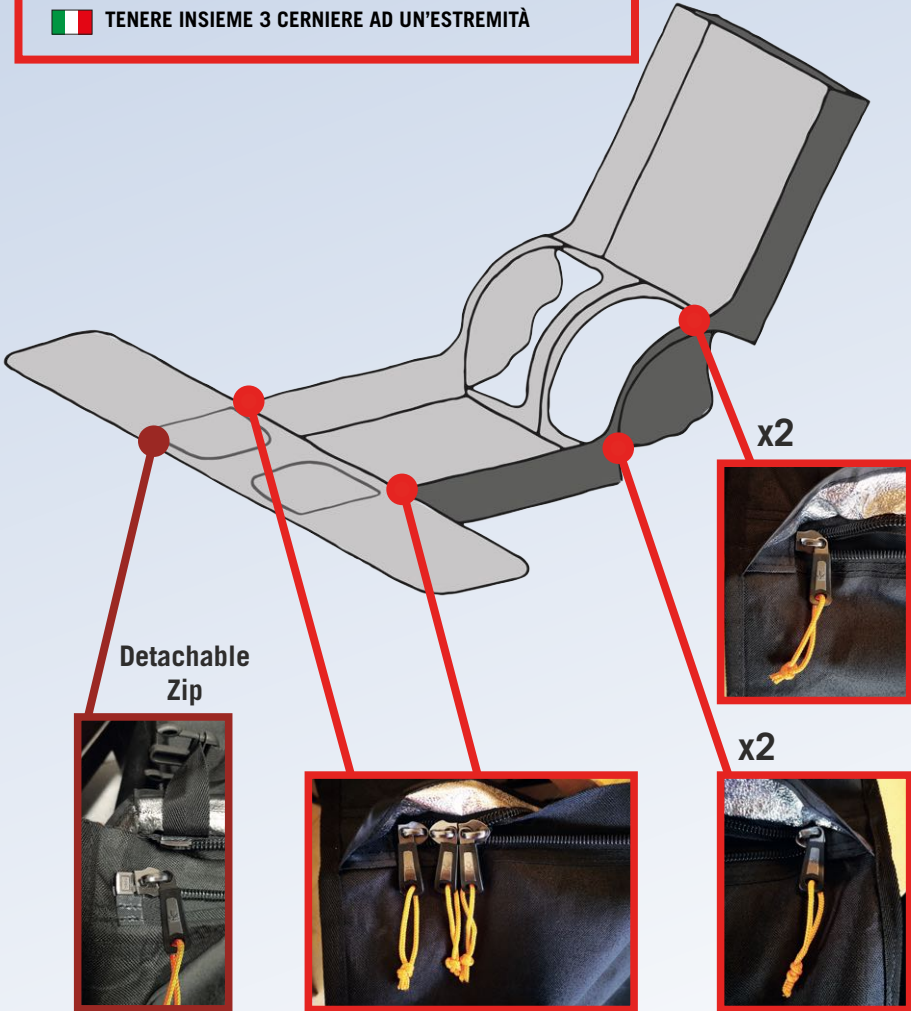

DR300



PROFESSIONAL

DARK ROOM 300 : STRUCTURE ASSEMBLY

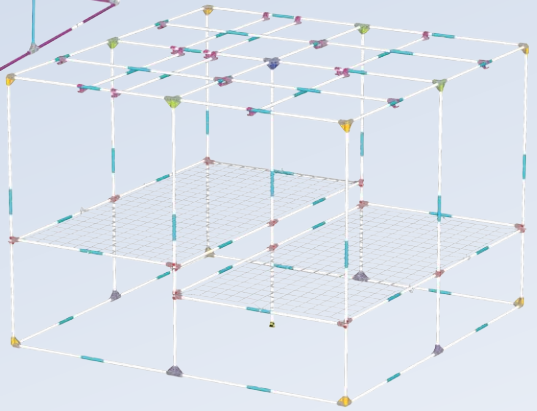
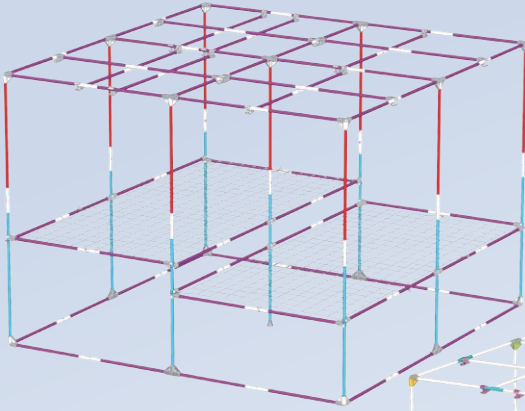

VIDEO ASSEMBLY
TENT DR300



- 9x T25-120
- 9x T25-100
- 84x T25-75
- 51x T25-Link



8x C25-Y

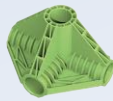

4x C25-K



4x C25-T



1x C25-XI



1x C25-RF



24x C25-SB



20x C25-H

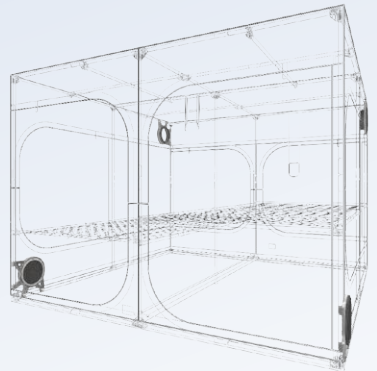

VIDEO ASSEMBLY
DUCTING FLANGE



VIDEO ASSEMBLY
CABLE FLANGE





PROFESSIONAL

DARK ROOM 300 : CANVAS ASSEMBLY

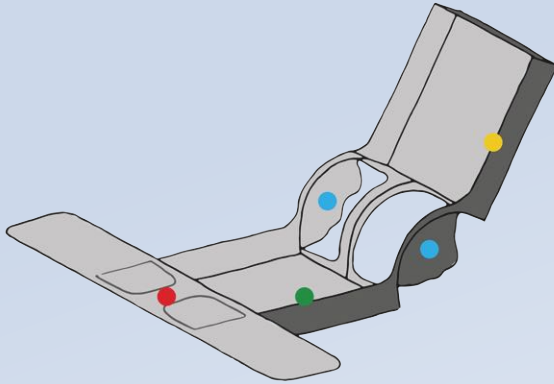

-  TOP
-  DOOR
-  BOTTOM
-  WINDOW

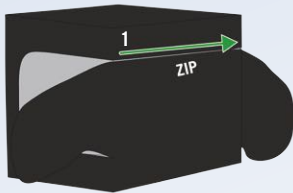
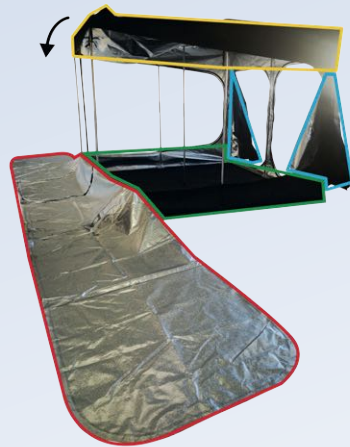
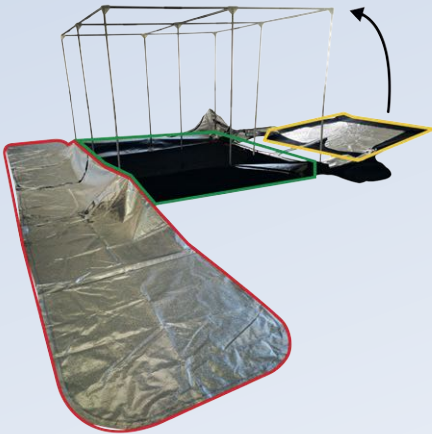

**CLOSE
DETACHABLE ZIP**

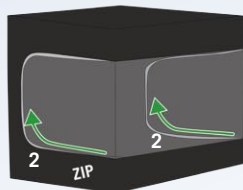

CLOSE ZIP

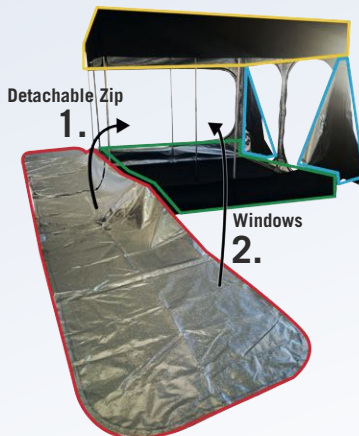

VIDEO



DR300

OPEN ALL ZIP BEFORE ASSEMBLY



OPEN ALL ACCESSES **THEN**
PUT THE CANVAS ON



OUVRIER TOUT LES ACCÈS **PUIS**
METTRE LA TOILE



ABRIR TODOS LOS ACCESOS
LUEGO PONTE EL LIENZO



ALLE ZUGÄNGE ÖFFNEN **DANN**
LEGEN SIE DIE LEINWANDE AB



ALLE TOEGANGEN OPENSTELLEN
DAN ZET JE HET DOEK OP



APRIRE TUTTI GLI ACCESSI **POI**
METTERE LA TELA DI CANAPA SU

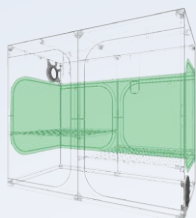
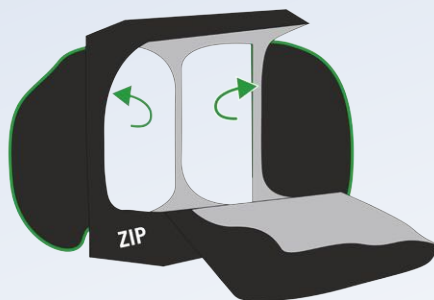
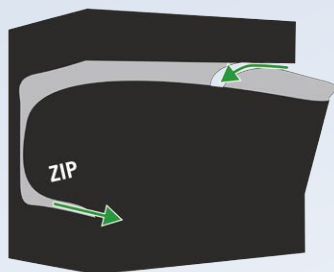

OPEN WINDOWS

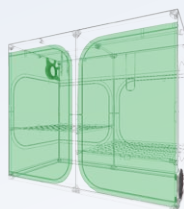

OPEN DOORS



PROFESSIONAL

DARK ROOM 240W : ZIP OPENING



KEEP 3 CARRIAGES TOGETHER AT ONE END



MAINTENIR 3 ZIPS ENSEMBLE À UNE EXTRÉMITÉ



MANTENER 3 CREMALLERAS JUNTAS EN UN EXTREMO



3 REIßVERSCHLÜSSE AN EINEM ENDE ZUSAMMENHALTEN



HOUD 3 RITSEN BIJ ELKAAR AAN ÉÉN KANT



TENERE INSIEME 3 CERNIERE AD UN'ESTREMITÀ

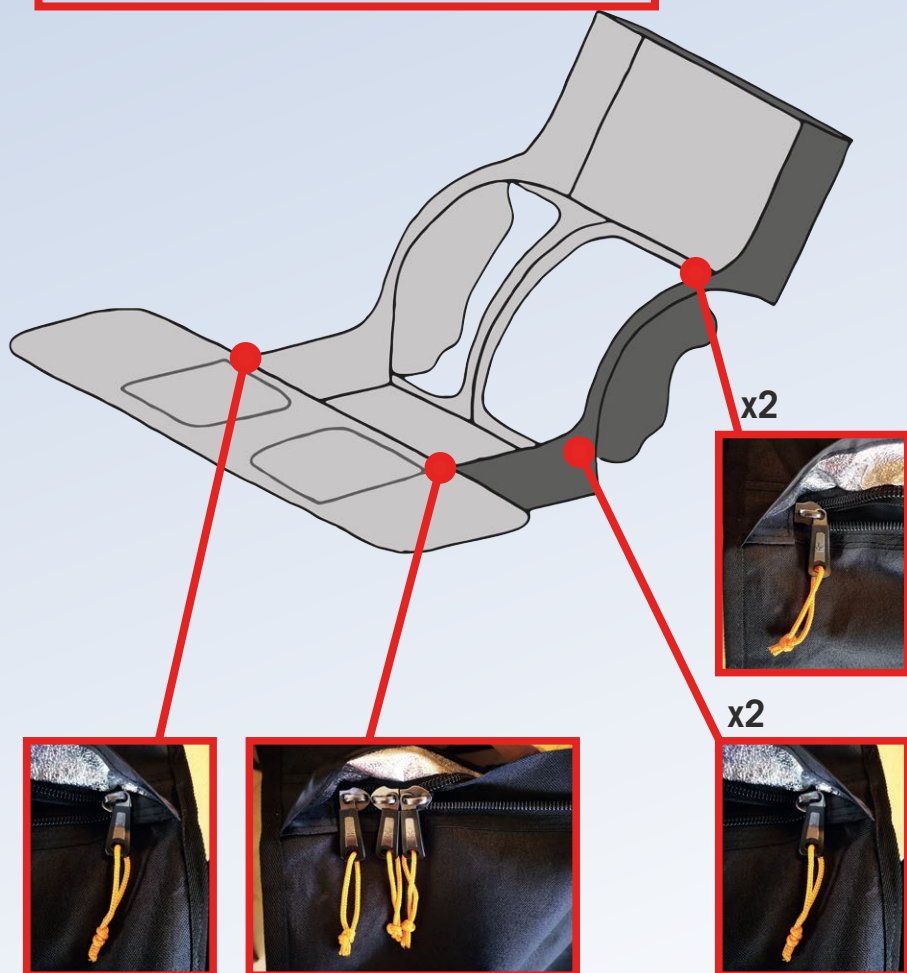

DR240W



PROFESSIONAL

DARK ROOM 240W : STRUCTURE ASSEMBLY

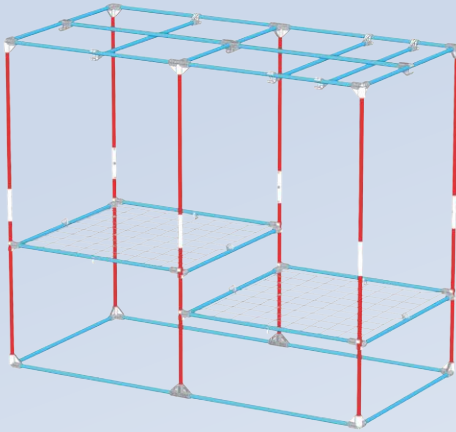

**VIDEO ASSEMBLY
TENT DR240W**

- 26x T25-120
- 12x T25-100
- 6x T25-Link



8x C25-Y

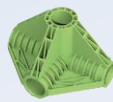

2x C25-K



2x C25-T



16x C25-SB



10x C25-H

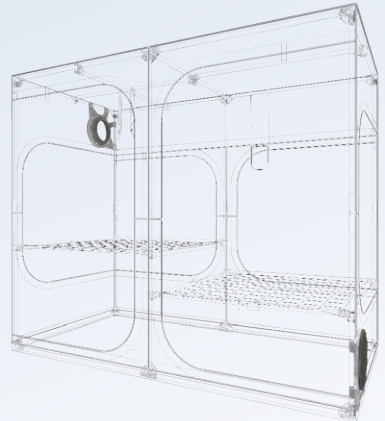

**VIDEO ASSEMBLY
DUCTING FLANGE**



**VIDEO ASSEMBLY
CABLE FLANGE**





PROFESSIONAL

DARK ROOM 240W : CANVAS ASSEMBLY

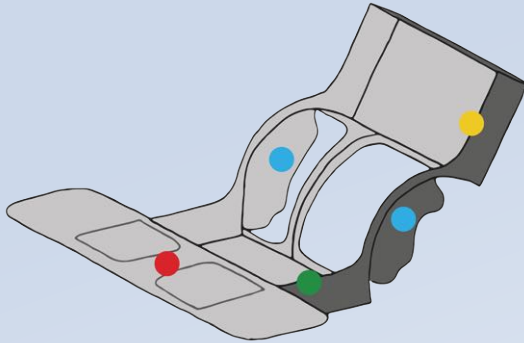

-  TOP
-  DOOR
-  BOTTOM
-  WINDOW

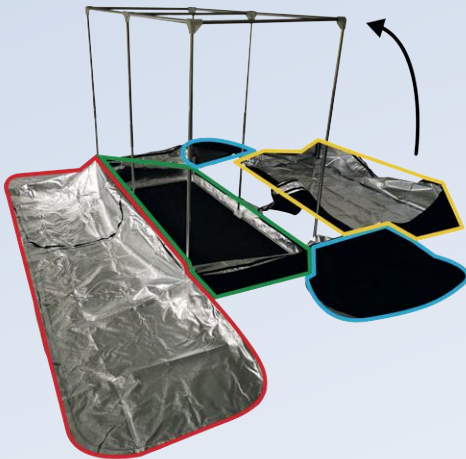

VIDEO



DR240W

OPEN ALL ZIP BEFORE ASSEMBLY



OPEN ALL ACCESSES **THEN**
PUT THE CANVAS ON



OUVRIRE TOUT LES ACCÈS **PUIS**
METTRE LA TOILE



ABRIR TODOS LOS ACCESOS
LUEGO PONTE EL LIENZO



ALLE ZUGÄNGE ÖFFNEN **DANN**
LEGEN SIE DIE LEINWANDE AB



ALLE TOEGANGEN OPENSTELLEN
DAN ZET JE HET DOEK OP



APRIRE TUTTI GLI ACCESSI **POI**
METTERE LA TELA DI CANAPA SU

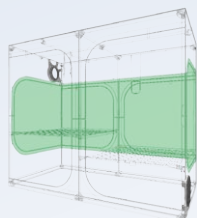
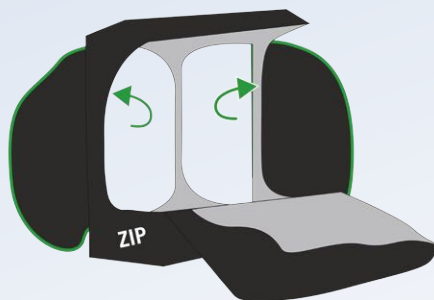
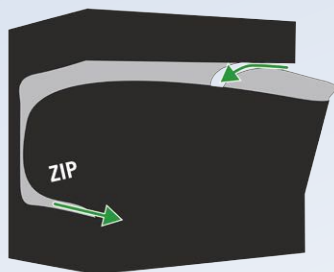

OPEN WINDOWS

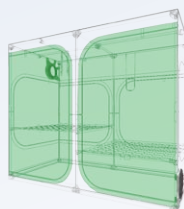

OPEN DOORS



PROFESSIONAL

DARK ROOM 300W : ZIP OPENING



KEEP 3 CARRIAGES TOGETHER AT ONE END



MAINTENIR 3 ZIPS ENSEMBLE À UNE EXTRÉMITÉ



MANTENER 3 CREMALLERAS JUNTAS EN UN EXTREMO



3 REIßVERSCHLÜSSE AN EINEM ENDE ZUSAMMENHALTEN



HOUD 3 RITSEN BIJ ELKAAR AAN ÉÉN KANT



TENERE INSIEME 3 CERNIERE AD UN'ESTREMITÀ

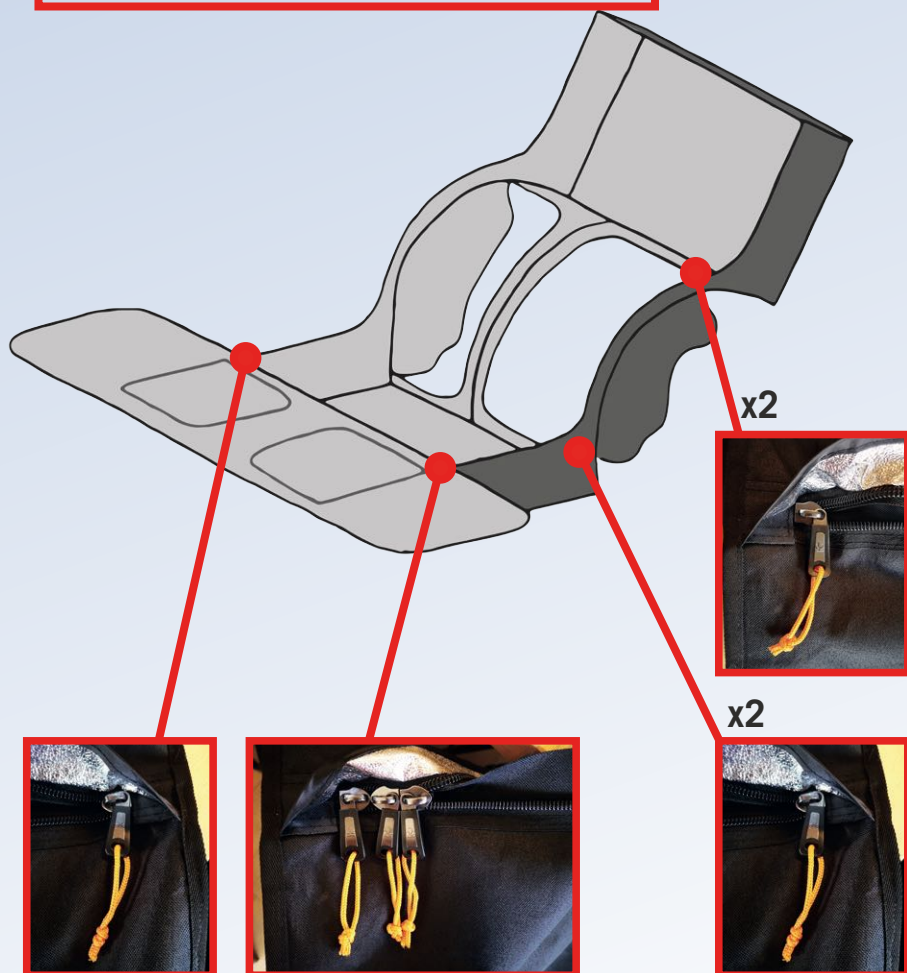

DR300W



PROFESSIONAL

DARK ROOM 300W : STRUCTURE ASSEMBLY

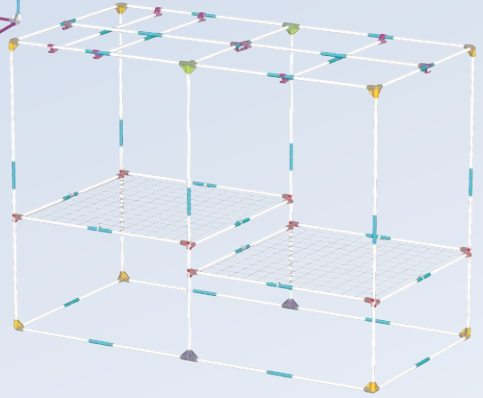
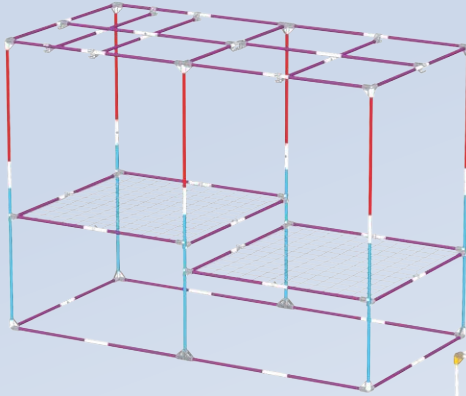

**VIDEO ASSEMBLY
TENT DR240W**



- 6x T25-120
- 6x T25-100
- 52x T25-75
- 32x T25-Link

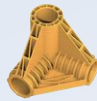

8x C25-Y

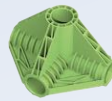

2x C25-K



2x C25-T



16x C25-SB



10x C25-H

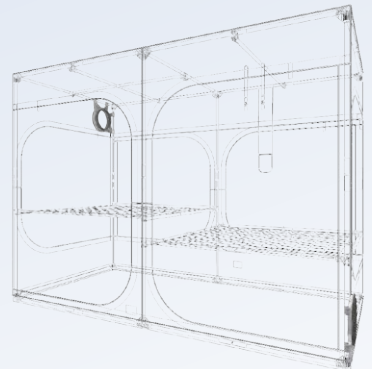

**VIDEO ASSEMBLY
DUCTING FLANGE**



**VIDEO ASSEMBLY
CABLE FLANGE**





PROFESSIONAL

DARK ROOM 300W : CANVAS ASSEMBLY

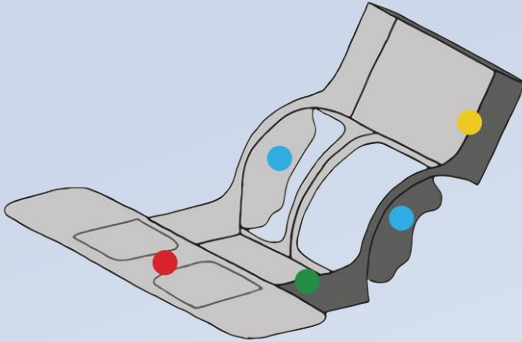

-  TOP
-  DOOR
-  BOTTOM
-  WINDOW

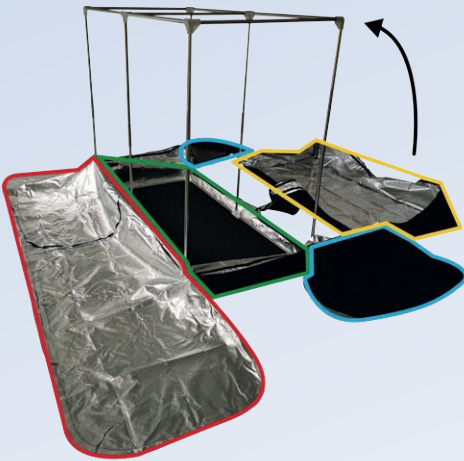

VIDEO



DR300W

WARNING



EN This product contains heat-sensitive materials that can ignite if misused (tent canvas, PocketIT, StrapIT, Cable flange, socks...) **FR** Ce produit contient des matériaux thermosensibles qui peuvent s'enflammer en cas de mauvaise utilisation (Enveloppe de la tente, PocketIT, StrapIT, Cable Flange, Chaussettes...) **SP** Este producto contiene materiales sensibles al calor que pueden encenderse si se usan mal (Carpa del armario, PocketIT, StrapIT, Cable Flange, bocas ajustables...). **DE** Dieses Produkt enthält wärmeempfindliche Materialien, die sich bei missbräuchlicher Verwendung entzünden können (Zeltplane, PocketIT, StrapIT, Cable Flange, Socken...) **NL** Dit product bevat warmtegevoelige materialen die bij verkeerd gebruik kunnen ontbranden (tentdoek, PocketIT, StrapIT, Cable Flange, sokken...). **IT** Questo prodotto contiene materiali sensibili al calore che possono infiammarsi in caso di uso improprio (Tessuto del grow box, PocketIT, StrapIT, Cable Flange...).



EN Make sure that all electrical products used with the tent are properly secured, so that they cannot fall out if the tent is shaken. **FR** Veillez à ce que tous les produits électriques utilisés avec la tente soient correctement fixés, afin qu'ils ne puissent pas tomber si la tente est secouée. **SP** Asegúrate de que todos los productos eléctricos utilizados con el armario estén bien asegurados para que no se caigan si la tienda se sacude. **DE** Stellen Sie sicher, dass alle mit diesem Zelt verwendeten Produkte den in Ihrem Land geltenden Normen entsprechen. Wenn Sie feststellen, dass das Produkt beschädigt ist, verwenden Sie es nicht. **NL** Zorg ervoor dat alle producten die met deze tent worden gebruikt, voldoen aan de normen die in uw land van kracht zijn. Als u merkt dat het product beschadigd is, gebruik het dan niet. **IT** Assicurarsi che tutti i prodotti elettrici utilizzati con la tenda siano correttamente fissati in modo che non possano cadere se el rgow box viene scossa.

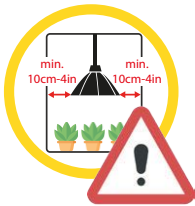

EN Ensure that any heat source is far away enough from heat sensitive materials included in this tent, and that your tent is properly ventilated. Lighting system should be installed at least 10cm (4in) from heat sensitive materials. **FR** Assurez-vous que toute source de chaleur soit suffisamment éloignée des matériaux sensibles à la chaleur inclus dans cette tente, et que votre tente soit correctement ventilée. Le système d'éclairage doit être installé à au moins 10cm (4in) des matériaux sensibles à la chaleur. **SP** Asegúrese de que cualquier fuente de calor esté lo suficientemente lejos de los materiales sensibles al calor incluidos en este armario, y que su armario esté debidamente ventilado. Los sistemas de iluminación deben ser instalados al menos a 10cm (4in) de distancia de cualquier material sensible al calor. **DE** Stellen Sie sicher, dass jede

FIRE & VENTILATION PRECAUTIONS

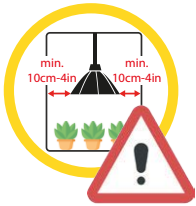

Wärmequelle weit genug von wärmeempfindlichen Materialien entfernt ist, die in diesem Zelt enthalten sind, und dass Ihr Zelt richtig belüftet ist. Das Beleuchtungssystem sollte mindestens 10cm (4in) von wärmeempfindlichen Materialien entfernt installiert werden. **NL** Zorg ervoor dat elke warmtebron ver genoeg verwijderd is van de warmtegevoelige materialen in deze tent en dat uw tent goed geventileerd is. Verlichtingssysteem moet ten minste 10cm (4in) van warmtegevoelige materialen worden geïnstalleerd. **IT** Assicuratevi che qualsiasi fonte di calore sia sufficientemente lontana dai materiali sensibili al calore inclusi in questo grow box e che el vostro grow box sia adeguatamente ventilato. I sistemi di illuminazione devono essere installati ad almeno 10cm (4in) di distanza da qualsiasi materiale sensibile al calore.



EN Make sure that all products used with this tent comply with the standards in force in your country. If you find that the product is damaged, do not use it. **FR** Assurez-vous que tous les produits utilisés avec cette tente sont conformes aux normes en vigueur dans votre pays. Si vous constatez que le produit est endommagé ou abîmé, ne l'utilisez pas. **SP** Asegúrese de que todos los productos utilizados con el armario cumplen con las normas vigentes en su país. Si encuentra que el producto está dañado o mutilado, no lo use. **DE** Stellen Sie sicher, dass alle mit diesem Zelt verwendeten Produkte den in Ihrem Land geltenden Normen entsprechen. Wenn Sie feststellen, dass das Produkt beschädigt ist, verwenden Sie es nicht. **NL** Zorg ervoor dat alle producten die met deze tent worden gebruikt, voldoen aan de normen die in uw land van kracht zijn. Als u merkt dat het product beschadigd is, gebruik het dan niet. **IT** Assicuratevi che tutti el grow box utilizzati con questo prodotto siano conformi alle norme in vigore nel vostro paese. Se trovate che il prodotto è danneggiato o mutilato, non usarlo.



EN Do not leave your tent unsupervised in the presence of young children. **FR** Ne laissez pas votre tente sans surveillance en présence de jeunes enfants. **SP** No deje su armario desatendida en presencia de pequeños niños. **DE** Verlassen Sie Ihr Zelt nicht unbeaufsichtigt in Anwesenheit von kleinen Kindern. **NL** Laat uw tent niet onbeheerd achter in het bijzijn van jonge kinderen. **IT** Non lasciate el grow box incustodita in presenza di piccoli bambini.

WARNING

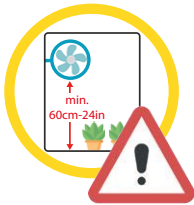

EN When possible, electrical products should be installed 60cm high minimum (24in) from the floor. Ensure that all electrical products used inside the tent do not come in contact with a water source.

FR Dans la mesure du possible, les produits électriques doivent être installés à une hauteur minimale de 60cm (24in) du sol. Veillez à ce que tous les produits électriques utilisés à l'intérieur de la tente ne soient pas en contact avec une source d'eau. **SP** Siempre que sea posible, los productos eléctricos deben instalarse a una altura mínima de 60cm (24in) del suelo. Asegúrate de que todos los productos eléctricos utilizados dentro de la tienda no entren en contacto con una fuente de agua. **DE** Wenn möglich, sollten elektrische Produkte in einer Höhe von mindestens 60cm (24in) über dem Boden installiert werden. Stellen Sie sicher, dass alle elektrischen Produkte, die im Zelt verwendet werden, nicht mit einer Wasserquelle in Berührung kommen. **NL** Indien mogelijk moeten elektrische producten minimaal 60cm hoog (24in) van de vloer worden geïnstalleerd. Zorg ervoor dat alle elektrische producten die in de tent worden gebruikt niet in contact komen met een waterbron. **IT** Dove possibile, i prodotti elettrici devono essere installati ad un'altezza minima di 60cm (24in) da terra. Assicurarsi che tutti i prodotti elettrici utilizzati all'interno della tenda non vengano a contatto con una fonte d'acqua.



EN We advise you to use LED lighting systems. If you need to use a discharge lamp like HPS, MH, CMH, CFL... take great care not to ignite the tent. **FR** Nous vous conseillons d'utiliser des systèmes d'éclairage LED. Si vous devez utiliser une lampe à décharge comme les HPS, MH, CMH, CFL... Faites très attention à ne pas enflammer la tente. **SP** Le aconsejamos que use sistemas de iluminación LED. Si tienes que usar una lámpara de descarga como HPS, MH, CMH, CFL... ten mucho cuidado de no encender el armario.

DE Wir raten Ihnen, LED-Beleuchtungssysteme zu verwenden. Wenn Sie eine Entladungslampe wie HPS, MH, CMH, CFL... verwenden müssen, achten Sie darauf, das Zelt nicht zu entzünden. **NL** Wij adviseren u om gebruik te maken van LED-verlichtingssystemen. Als u een ontladingslamp moet gebruiken zoals HPS, MH, CMH, CFL... let er dan op dat u de tent niet ontbrandt. **IT** Vi consigliamo di utilizzare sistemi di illuminazione a LED. Se dovete usare una lampada a scarica come HPS, MH, CMH, CFL... fate molta attenzione a non accendere el grow box.

FIRE & VENTILATION PRECAUTIONS

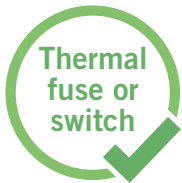

EN Lighting system must include a thermal safety system (thermal fuse or thermal switch). **FR** L'éclairage doit inclure un système de sécurité thermique (disjoncteur ou fusible thermique). **SP** El alumbrado debe incluir un sistema de seguridad térmica (disyuntor térmico o hot melt). **DE** Beleuchtungssystem muss ein thermisches Sicherheitssystem enthalten (Thermosicherung oder Thermoschalter). **NL** Verlichtingssysteem moet een thermische beveiliging bevatten (thermische zekering of thermische schakelaar). **IT** L'illuminazione deve comprendere un sistema di sicurezza termica (interruttore termico o hot melt).



EN PocketIT : Do not hang the PocketIT close to your lighting and ventilation system (wind generated by a fan may cause the PocketIT to touch a lighting system). **FR** PocketIT : Ne pas accrocher le PocketIT proche de système d'éclairage et de ventilation (le vent généré par un ventilateur peut amener le PocketIT à toucher un système d'éclairage). **SP** PocketIT: No cuelgue el PocketIT cerca de sistemas de iluminación y ventilación (el viento generado por un ventilador puede hacer que el PocketIT toque un sistema de iluminación). **DE** PocketIT : Hängen Sie den PocketIT nicht in der Nähe Ihres Beleuchtungs- und Belüftungssystems auf (durch einen Ventilator erzeugter Wind kann dazu führen, dass der PocketIT ein Beleuchtungssystem berührt). **NL** PocketIT : Hang de PocketIT niet in de buurt van uw verlichtings- en ventilatiesysteem (wind die wordt opgewekt door een ventilator kan ervoor zorgen dat de PocketIT een verlichtingssysteem raakt). **IT** PocketIT: Non appendere il PocketIT vicino a sistemi di illuminazione e ventilazione (il vento generato da un ventilatore può far sì che il PocketIT tocchi un sistema di illuminazione).



EN StrapIT : Do not use the StrapIT to hang lighting system or other high temperature system. **FR** StrapIT : Ne pas utiliser les StrapIT pour suspendre les systèmes d'éclairage ou tout autre système à haute température. **SP** StrapIT: No utilice los StrapIT para suspender sistemas de iluminación o cualquier otro sistema de alta temperatura. **DE** StrapIT : Verwenden Sie den StrapIT nicht, um ein Beleuchtungssystem oder ein anderes Hochtemperatursystem aufzuhängen. **NL** StrapIT : Gebruik de StrapIT niet om het verlichtingssysteem of andere hoge temperatuur systemen op te hangen. **IT** StrapIT: Non utilizzare StrapIT per sospendere i sistemi di illuminazione o qualsiasi altro sistema ad alta temperatura.

METRIC

DARK ROOM		WGT	HANDLING		MONKEY	LIGHTING ADVISED		VOL	EXTRACTOR ADVISED WHEN FILTER ON (**)					
REF	DESIGNATION	Net kg	#	L cm	Weight Per Pole	Weight Per Tent	FAN Advised	Level III LED PE2.7	Level II LED PE2.7	m3	1 min cycle		2 min cycle	
DR160	Dark Room 150 x 150 x 217 cm	26,8	3	150	25 kg	75 kg	1 MF30	600 W	400 W	4,9	Extraction	Intake	Extraction	Intake
DR240	Dark Room 237 x 237 x 200 cm	46,2	9	120	25 kg	225 kg	2 MF30	1600 W	800 W	11,2	900 m3/h	50%	650 m3/h	50%
DR300	Dark Room 297 x 297 x 217 cm	66,6	10	150	25 kg	250 kg	2 MF30	2400 W	1600 W	19,1	1200 m3/h	50%	900 m3/h	50%
DR340W	Dark Room 237 x 120 x 200 cm	RA.00	5	120	25 kg	125 kg	1 MF30	800 W	400 W	5,7	650 m3/h	50%	350 m3/h	-
DR300W	Dark Room 297 x 150 x 217 cm	RA.00	5	150	25 kg	125 kg	2 MF30	1200 W	800 W	9,7	900 m3/h	50%	600 m3/h	50%

IMPERIAL

DARK ROOM		WGT	HANDLING		MONKEY	LIGHTING ADVISED		VOL	EXTRACTOR ADVISED WHEN FILTER ON (**)					
REF	DESIGNATION	Net lb	#	L in	Weight Per Pole	Weight Per Tent	FAN Advised	Level III LED PE2.7	Level II LED PE2.7	cf	1 min cycle		2 min cycle	
DR160	Dark Room 5' x 5' x 85"	59	3	59	50 lb	150 lb	1 MF30	600 W	400 W	177	400 cfm	50%	210 cfm	50%
DR240	Dark Room 8' x 8' x 79"	RA.00	9	47	50 lb	450 lb	2 MF30	1600 W	800 W	440	550 cfm	50%	400 cfm	50%
DR300	Dark Room 10' x 10' x 85"	RA.00	147	10	59	50 lb	2 MF30	2400 W	1600 W	697	700 cfm	50%	550 cfm	50%
DR340W	Dark Room 8' x 4' x 79"	RA.00	70	5	47	50 lb	1 MF30	800 W	400 W	223	400 cfm	50%	210 cfm	50%
DR300W	Dark Room 10' x 5' x 85"	RA.00	95	5	59	50 lb	2 MF30	1200 W	800 W	352	550 cfm	50%	400 cfm	50%



info@secretjardin.com

Secretjardin_

Secret Jardin Official

Secret Jardin

www.secretjardin.com